

16K Serial EEPROM with I2C bus

KK24LC16B

DESCRIPTION

The KK24LC16B is a 16K bit Electrically Erasable PROM. The chip is organized as eight blocks of 256 x 8 bit memory with a 2-wire serial interface. Low voltage design permits operation down to 2.5 volts with standby and active currents of only 5 μ A and 1 mA respectively. The KK24LC16B also has a page-write capability for up to 16 bytes of data.

FEATURES

- Single supply with operation down to 2.5V
- Low power CMOS technology
 - 1 mA active current typical
 - 10 μ A standby current typical at 5.5V
 - 5 μ A standby current typical at 3.0V
- Organized as 8 blocks of 256 bytes (8 x 256 x 8)
- 2-wire serial interface bus, I²C compatible
- Schmitt trigger inputs for noise suppression
- Output slope control to eliminate ground bounce
- 100 kHz (E-temp) and 400 kHz (C/I-temp) compatibility
- Self-timed write cycle (including auto-erase)
- Page-write buffer for up to 16 bytes
- 2 ms typical write cycle time for page-write
- Hardware write protect for entire memory
- Can be operated as a serial ROM
- 1,000,000 erase/write cycles guaranteed
- Data retention > 200 years
- Temperature range -40°C to +85°C

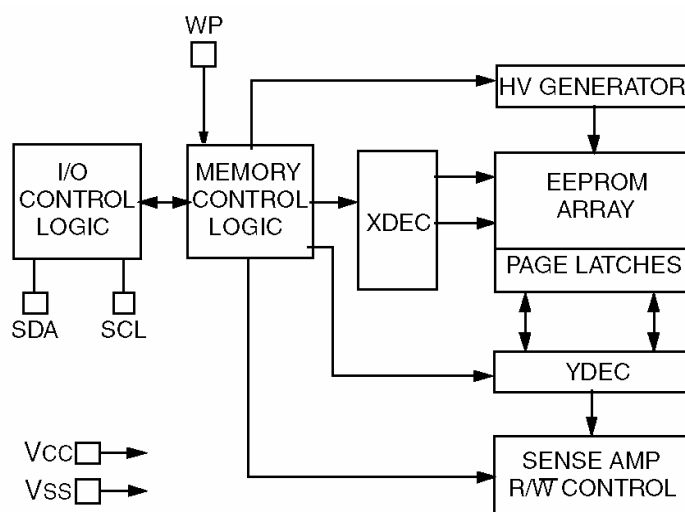
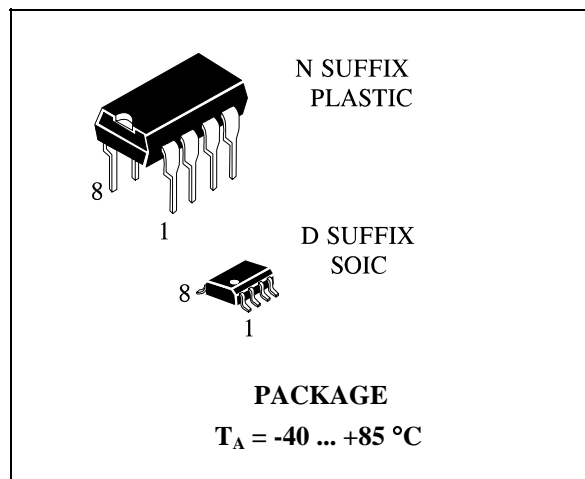

Figure 1. Representative Block Diagram

ELECTRICAL CHARACTERISTICS
Absolute Maximum Ratings

Symbol	Parameter	Value		Unit
		min	max	
V_{CC}	Supply voltage	0	7.0	V
V_I	Input voltage	-0.3	$V_{CC}+1V$	V
T	Storage temperature	-65	150	°C
Ta	Ambient temperature	-65	125	°C

Maximum Ratings

Symbol	Parameter	Value		Unit
		min	max	
V_{CC}	Supply voltage	2.5	5.5	V
I_{OL}	Low level output current	-	3.0	mA
T	Operating ambient temperature	-40	85	°C

DC CHARACTERISTICS ($V_{CC} = +2.5V$ to $+5.5V$ $T_{amb} = -40^{\circ}C$ to $+85^{\circ}C$)

Symbol	Parameter	Mode of measurements	Value		Unit
			Min	Max	
I_{CCS}	Standby current	$V_{CC} = 3.0 V$ $V_{CC} = 5.5 V$ $SDA=SCL=V_{CC}$	-	30 100	uA
$I_{CCO(RD)}$	Operating current (read mode)	$f_{SCL} = 400 kHz$ $V_{CC} = 5.5 V$		1.0	mA
$I_{CCO(E/WR)}$	Operating current (erase/write mode)	$f_{SCL} = 400 kHz$ $V_{CC} = 5.5 V$		3.0	
I_{LI}	Input leakage current	$V_{IN} = (0.1 - 5.5) V$	-10	10	uA
I_{LO}	Output leakage current	$V_{OUT} = (0.1 - 5.5) V$	-10	10	
C_{IN}	Input pin capacitance	$V_{CC} = 5.0 V$, $f = 1 MHz$ $T = 25^{\circ}C$	-	10	pF
C_{out}	Output pin capacitance	$V_{CC} = 5.0V$, $f = 1 MHz$ $T = 25^{\circ}C$		10	
V_{HYS}	Hysteresis of Schmitt trigger inputs		$0.05 V_{CC}$	-	V
V_{OL}	Low level output voltage	$I_{OL} = 3.0 mA$, $V_{CC} = 2.5 V$	-	0.4	
t_S	Time of data storage	$T = 25^{\circ}C$	200	-	years
$N_{C(E/WR)}$	Number of ERASE/WRITE cycles guaranteed		100000 0		pcs

**N SUFFIX PLASTIC DIP
(MS - 001BA)**

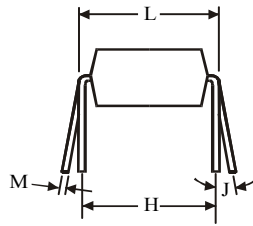
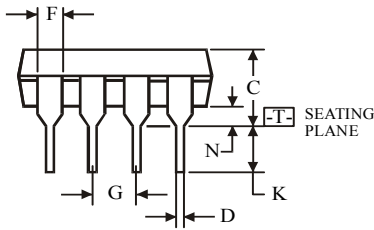
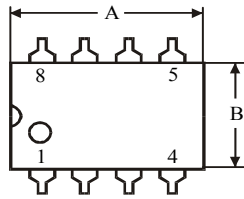
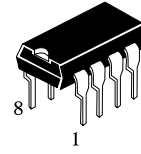

$\oplus 0.25 (0.010) \text{ (M) T}$

Symbol	Dimension, mm	
	MIN	MAX
A	8.51	10.16
B	6.1	7.11
C		5.33
D	0.36	0.56
F	1.14	1.78
G	2.54	
H	7.62	
J	0°	10°
K	2.92	3.81
L	7.62	8.26
M	0.2	0.36
N	0.38	

NOTES:

- Dimensions "A", "B" do not include mold flash or protrusions.
Maximum mold flash or protrusions 0.25 mm (0.010) per side.

**D SUFFIX SOIC
(MS - 012AA)**

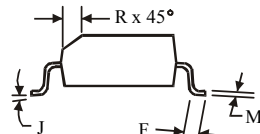
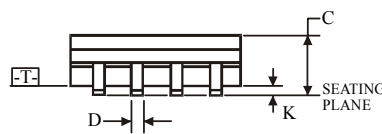
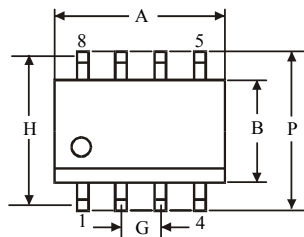
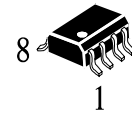

$\oplus 0.25 (0.010) \text{ (M) T C (M)}$

Symbol	Dimension, mm	
	MIN	MAX
A	4.8	5
B	3.8	4
C	1.35	1.75
D	0.33	0.51
F	0.4	1.27
G	1.27	
H	5.72	
J	0°	8°
K	0.1	0.25
M	0.19	0.25
P	5.8	6.2
R	0.25	0.5

NOTES:

- Dimensions A and B do not include mold flash or protrusion.
- Maximum mold flash or protrusion 0.15 mm (0.006) per side for A; for B - 0.25 mm (0.010) per side.